

FDP3205

N-Channel PowerTrench® MOSFET

55V, 100A, 7.5mΩ

Features

- $R_{DS(on)} = 6.1m\Omega$ (Typ.) @ $V_{GS} = 10V, I_D = 59A$
- High performance trench technology for extremely low $R_{DS(on)}$
- High power and current handling capability
- RoHS compliant



Description

- This N-Channel MOSFET is produced using Fairchild Semiconductor's advanced PowerTrench process that has been especially tailored to minimize the on-state resistance and yet maintain superior switching performance.

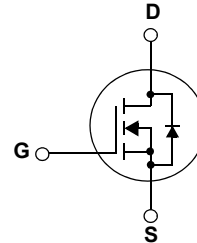
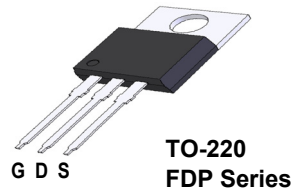

MOSFET Maximum Ratings $T_C = 25^\circ C$ unless otherwise noted

Symbol	Parameter		Ratings	Units
V_{DSS}	Drain to Source Voltage		55	V
V_{GSS}	Gate to Source Voltage		± 20	V
I_D	Drain Current	-Continuous ($T_C = 25^\circ C$) (Note 1)	100	A
I_{DM}	Drain Current	- Pulsed	390	A
E_{AS}	Single Pulsed Avalanche Energy (Note 2)		365	mJ
P_D	Power Dissipation	($T_C = 25^\circ C$)	150	W
		- Derate above $25^\circ C$	1.0	W/ $^\circ C$
T_J, T_{STG}	Operating and Storage Temperature Range		-55 to +175	$^\circ C$

Thermal Characteristics

Symbol	Parameter	Ratings	Units
$R_{\theta JC}$	Thermal Resistance, Junction to Case	1.0	$^\circ C/W$
$R_{\theta JA}$	Thermal Resistance, Junction to Ambient	62.5	

Package Marking and Ordering Information $T_C = 25^\circ\text{C}$ unless otherwise noted

Device Marking	Device	Package	Reel Size	Tape Width	Quantity
FDP3205	FDP3205	TO-220	-	-	50units

Electrical Characteristics

Symbol	Parameter	Test Conditions	Min.	Typ.	Max.	Units
--------	-----------	-----------------	------	------	------	-------

Off Characteristics

$B_{V_{DSS}}$	Drain to Source Breakdown Voltage	$I_D = 250\mu\text{A}, V_{GS} = 0\text{V}, T_J = 25^\circ\text{C}$	55	-	-	V
I_{DSS}	Zero Gate Voltage Drain Current	$V_{DS} = 44\text{V}, V_{GS} = 0\text{V}$	-	-	25	μA
		$V_{DS} = 44\text{V}, T_C = 150^\circ\text{C}$	-	-	250	
I_{GSS}	Gate to Body Leakage Current	$V_{GS} = \pm 20\text{V}, V_{DS} = 0\text{V}$	-	-	± 100	nA

On Characteristics

$V_{GS(th)}$	Gate Threshold Voltage	$V_{GS} = V_{DS}, I_D = 250\mu\text{A}$	3.5	-	5.5	V
$R_{DS(on)}$	Static Drain to Source On Resistance	$V_{GS} = 10\text{V}, I_D = 59\text{A}$	-	6.1	7.5	m Ω
		$V_{GS} = 10\text{V}, I_D = 59\text{A}$ $T_J = 175^\circ\text{C}$	-	12	-	

Dynamic Characteristics

C_{iss}	Input Capacitance	$V_{DS} = 25\text{V}, V_{GS} = 0\text{V}$ $f = 1\text{MHz}$	-	5810	7730	pF
C_{oss}	Output Capacitance		-	460	610	pF
C_{rss}	Reverse Transfer Capacitance		-	230	345	pF
R_G	Gate Resistance	$V_{GS} = 0\text{V}, f = 1\text{MHz}$	3	4	5	Ω
$Q_{g(tot)}$	Total Gate Charge at 10V	$V_{GS} = 0\text{V to } 10\text{V}$	-	93	120	nC
$Q_{g(th)}$	Threshold Gate Charge	$V_{GS} = 0\text{V to } 2\text{V}$	-	25.5	33	nC
Q_{gs}	Gate to Source Gate Charge	$V_{DS} = 44\text{V}$ $I_D = 59\text{A}$ $I_g = 1\text{mA}$	-	35	-	nC
Q_{gs2}	Gate Charge Threshold to Plateau		-	9.5	-	nC
Q_{gd}	Gate to Drain "Miller" Charge		-	32	-	nC

Switching Characteristics

t_{ON}	Turn-On Time	$V_{DD} = 28\text{V}, I_D = 59\text{A}$ $V_{GS} = 10\text{V}, R_{GEN} = 2.5\Omega$	-	170	350	ns
$t_{d(on)}$	Turn-On Delay Time		-	23	56	ns
t_r	Turn-On Rise Time		-	147	305	ns
$t_{d(off)}$	Turn-Off Delay Time		-	42	94	ns
t_f	Turn-Off Fall Time		-	18	46	ns
t_{OFF}	Turn-Off Time		-	60	130	ns

Drain-Source Diode Characteristics

V_{SD}	Drain to Source Diode Forward Voltage	$V_{GS} = 0\text{V}, I_{SD} = 59\text{A}$	-	-	1.3	V
t_{rr}	Reverse Recovery Time	$V_{GS} = 0\text{V}, I_{SD} = 59\text{A}$	-	43.3	-	ns
Q_{rr}	Reverse Recovery Charge	$di_F/dt = 100\text{A}/\mu\text{s}$	-	70.8	-	nC

Notes:

- 1: Calculated continuous current based on maximum allowable junction temperature. Package limited to 75A continuous, see Figure 9.
- 2: $L = 0.21\text{mH}, I_{AS} = 59\text{A}, V_{DD} = 50\text{V}, V_{GS} = 10\text{V}, R_G = 25\Omega$, Starting $T_J = 25^\circ\text{C}$

Typical Performance Characteristics

Figure 1. On-Region Characteristics

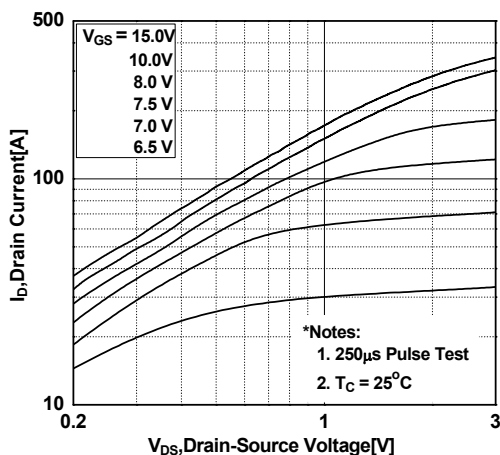

Figure 2. Transfer Characteristics

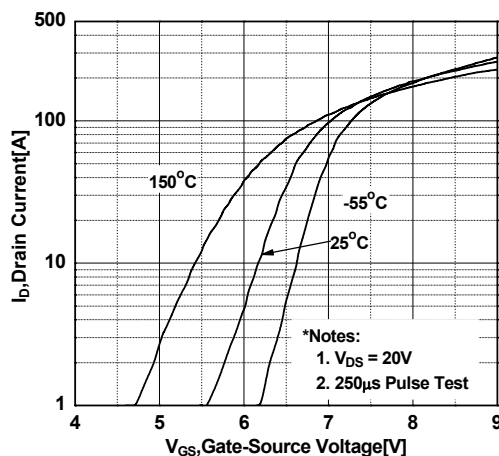

Figure 3. On-Resistance Variation vs. Drain Current and Gate Voltage

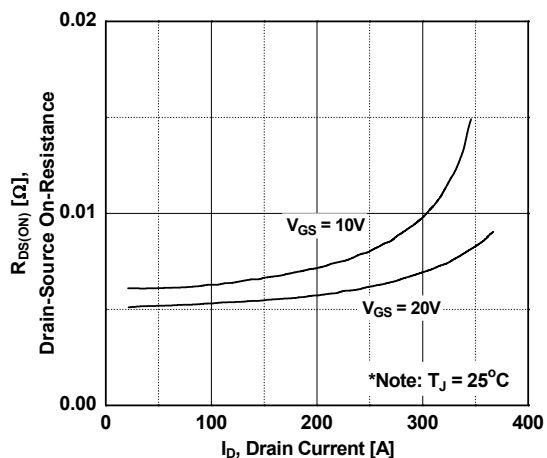

Figure 4. Body Diode Forward Voltage Variation vs. Source Current and Temperature

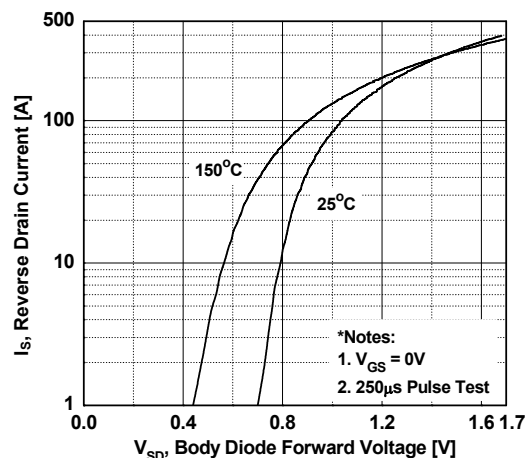

Figure 5. Capacitance Characteristics

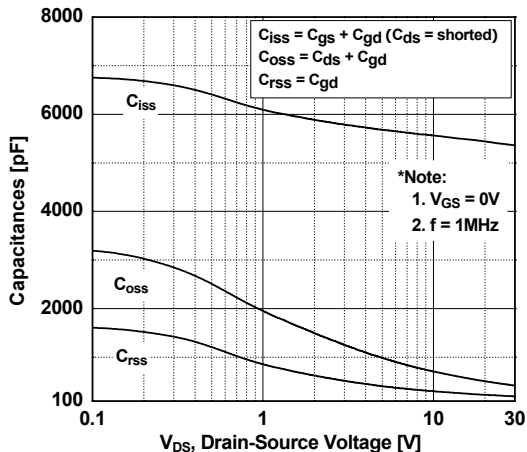
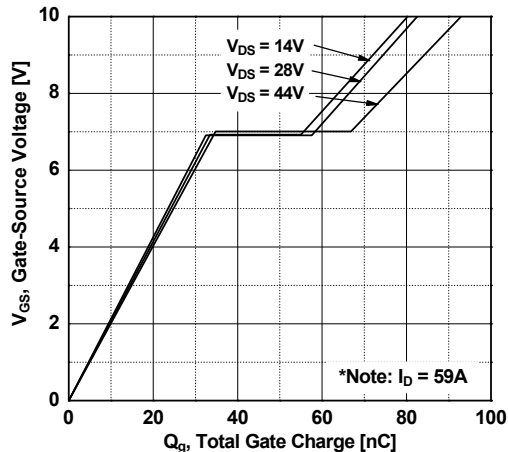

Figure 6. Gate Charge Characteristics



Typical Performance Characteristics (Continued)

Figure 7. Breakdown Voltage Variation vs. Temperature

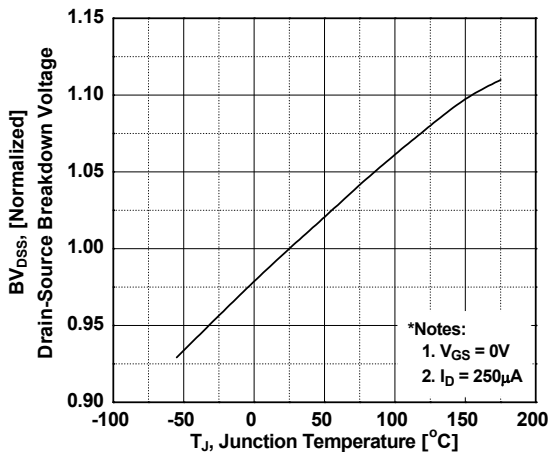

Figure 8. On-Resistance Variation vs. Temperature

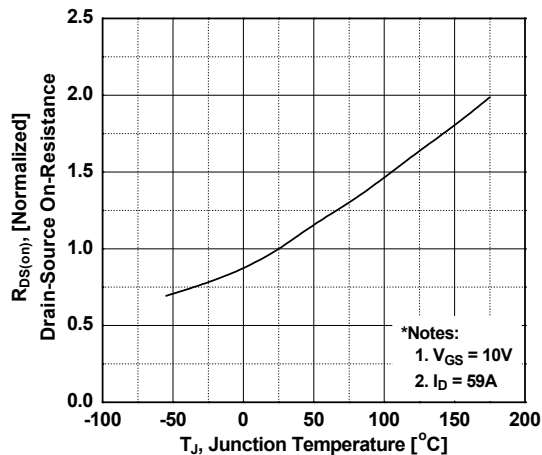

Figure 9. Maximum Safe Operating Area

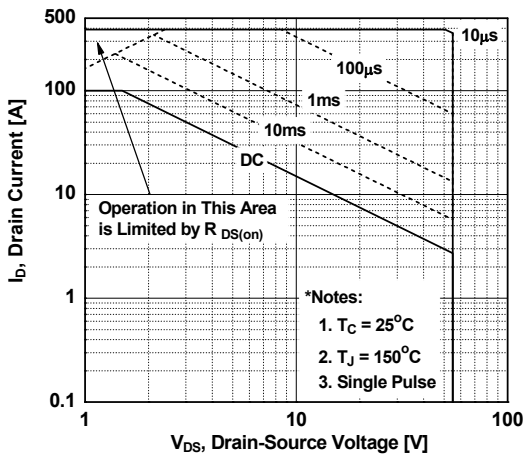

Figure 10. Maximum Drain Current vs. Case Temperature

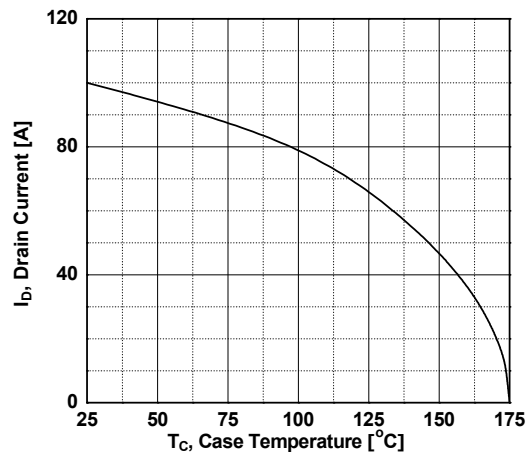
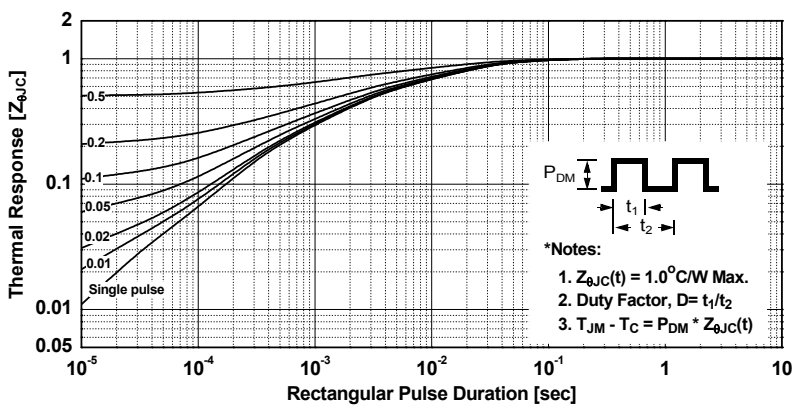
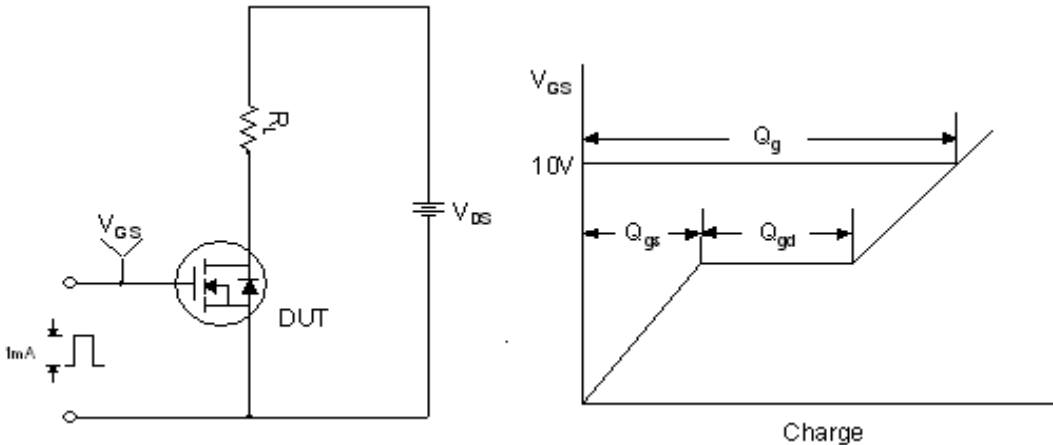

Figure 11. Transient Thermal Response Curve



Gate Charge Test Circuit & Waveform



Resistive Switching Test Circuit & Waveforms

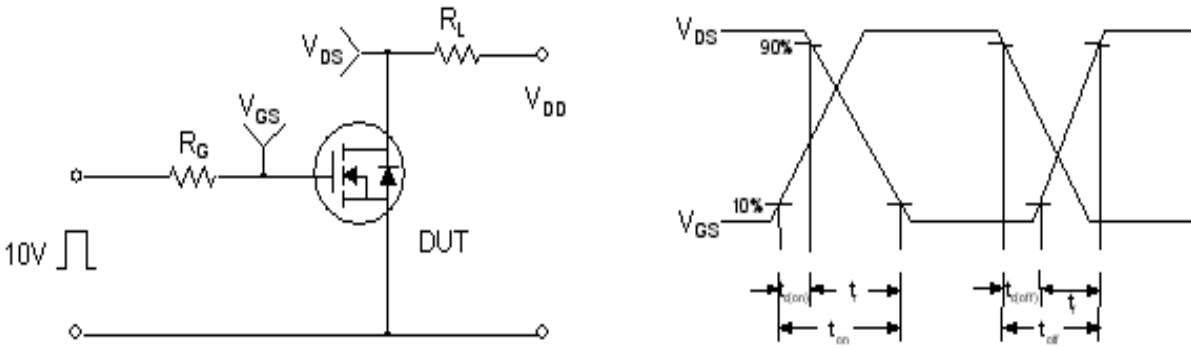

Unclamped Inductive Switching Test Circuit & Waveforms

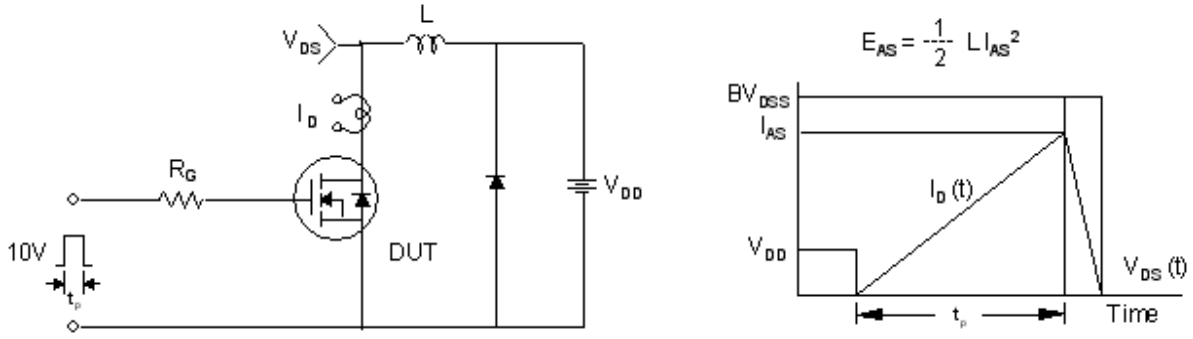

Peak Diode Recovery dv/dt Test Circuit & Waveforms

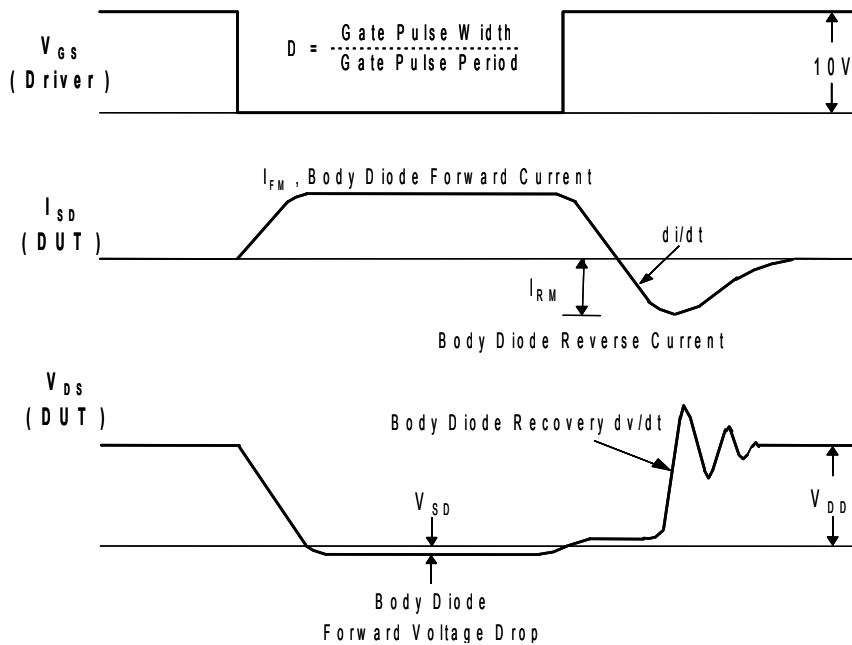
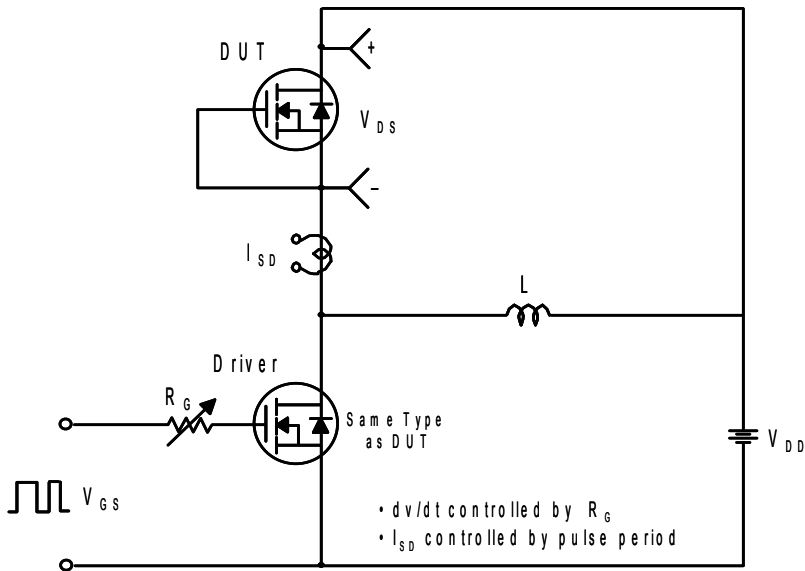

Mechanical Dimensions



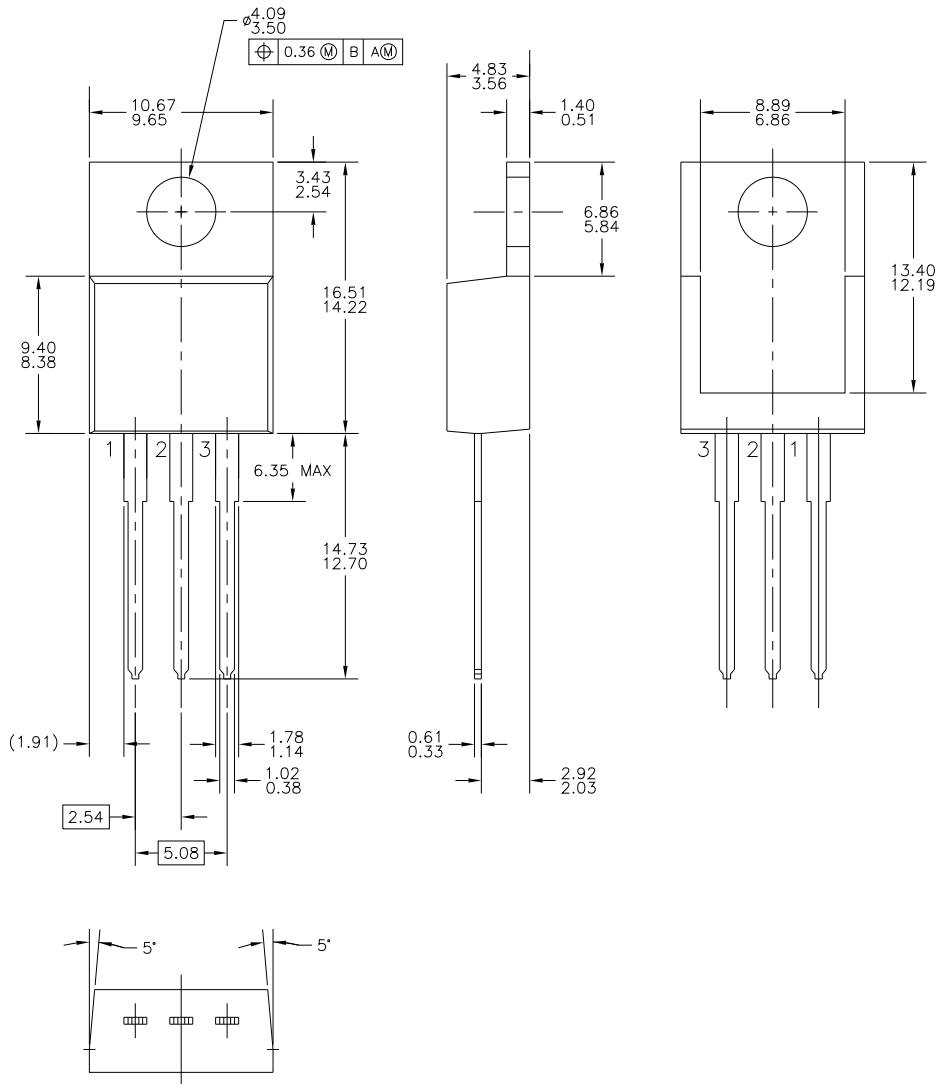

TO-220





TRADEMARKS

The following includes registered and unregistered trademarks and service marks, owned by Fairchild Semiconductor and/or its global subsidiaries, and is not intended to be an exhaustive list of all such trademarks.

- | | | | |
|---|---|---|---|
| ACEx® | FPS™ | PDP-SPM™ | The Power Franchise® |
| Build it Now™ | F-PFS™ | Power-SPM™ | the power franchise |
| CorePLUS™ | FRFET® | PowerTrench® | TinyBoost™ |
| CorePOWER™ | Global Power Resource SM | Programmable Active Droop™ | TinyBuck™ |
| CROSSVOLT™ | Green FPS™ | QFET® | TinyLogic® |
| CTL™ | Green FPS™ e-Series™ | QS™ | TINYOPTO™ |
| Current Transfer Logic™ | GTO™ | Quiet Series™ | TinyPower™ |
| EcoSPARK® | IntelliMAX™ | RapidConfigure™ | TinyPWM™ |
| EfficientMax™ | ISOPLANAR™ | Saving our world 1mW at a time™ | TinyWire™ |
| EZSWITCH™ * | MegaBuck™ | SmartMax™ | µSerDes™ |
|  | MICROCOUPLER™ | SMART START™ |  |
|  | MicroFET™ | SPM® | UHC® |
| Fairchild® | MicroPak™ | STEALTH™ | Ultra FRFET™ |
| Fairchild Semiconductor® | MillerDrive™ | SuperFET™ | UniFET™ |
| FACT Quiet Series™ | MotionMax™ | SuperSOT™-3 | Vcx™ |
| FACT® | Motion-SPM™ | SuperSOT™-6 | VisualMax™ |
| FAST® | OPTOLOGIC® | SuperSOT™-8 | |
| FastvCore™ | OPTOPLANAR® | SuperMOS™ | |
| FlashWriter® * |  |  | |

* EZSWITCH™ and FlashWriter® are trademarks of System General Corporation, used under license by Fairchild Semiconductor.

DISCLAIMER

FAIRCHILD SEMICONDUCTOR RESERVES THE RIGHT TO MAKE CHANGES WITHOUT FURTHER NOTICE TO ANY PRODUCTS HEREIN TO IMPROVE RELIABILITY, FUNCTION, OR DESIGN. FAIRCHILD DOES NOT ASSUME ANY LIABILITY ARISING OUT OF THE APPLICATION OR USE OF ANY PRODUCT OR CIRCUIT DESCRIBED HEREIN; NEITHER DOES IT CONVEY ANY LICENSE UNDER ITS PATENT RIGHTS, NOR THE RIGHTS OF OTHERS. THESE SPECIFICATIONS DO NOT EXPAND THE TERMS OF FAIRCHILD'S WORLDWIDE TERMS AND CONDITIONS, SPECIFICALLY THE WARRANTY THEREIN, WHICH COVERS THESE PRODUCTS.

LIFE SUPPORT POLICY

FAIRCHILD'S PRODUCTS ARE NOT AUTHORIZED FOR USE AS CRITICAL COMPONENTS IN LIFE SUPPORT DEVICES OR SYSTEMS WITHOUT THE EXPRESS WRITTEN APPROVAL OF FAIRCHILD SEMICONDUCTOR CORPORATION.

As used herein:

- Life support devices or systems are devices or systems which, (a) are intended for surgical implant into the body or (b) support or sustain life, and (c) whose failure to perform when properly used in accordance with instructions for use provided in the labeling, can be reasonably expected to result in a significant injury of the user.
- A critical component in any component of a life support, device, or system whose failure to perform can be reasonably expected to cause the failure of the life support device or system, or to affect its safety or effectiveness.

PRODUCT STATUS DEFINITIONS

Definition of Terms

Datasheet Identification	Product Status	Definition
Advance Information	Formative or In Design	This datasheet contains the design specifications for product development. Specifications may change in any manner without notice.
Preliminary	First Production	This datasheet contains preliminary data; supplementary data will be published at a later date. Fairchild Semiconductor reserves the right to make changes at any time without notice to improve design.
No Identification Needed	Full Production	This datasheet contains final specifications. Fairchild Semiconductor reserves the right to make changes at any time without notice to improve the design.
Obsolete	Not In Production	This datasheet contains specifications on a product that is discontinued by Fairchild Semiconductor. The datasheet is for reference information only.